

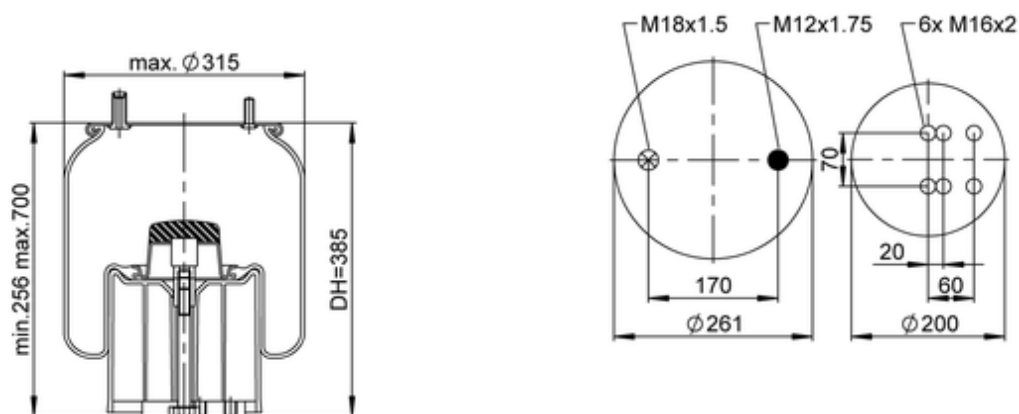





1R11-883

20920944



-  bolt or stud
-  hole
-  combination stud
-  air inlet

	9,7 kg
	
	M12x1.75: max. 45 Nm
	M16: max. 90 Nm
	M18x1.5: max. 70 Nm

**OE Manufacturer/Part No.**

Manufacturer	Original Part No.	Model
BPW	05.429.43.25.0	